

Data sheet | Item number: 221-413

COMPACT splicing connector; 3-conductor; with operating levers;  
transparent housing

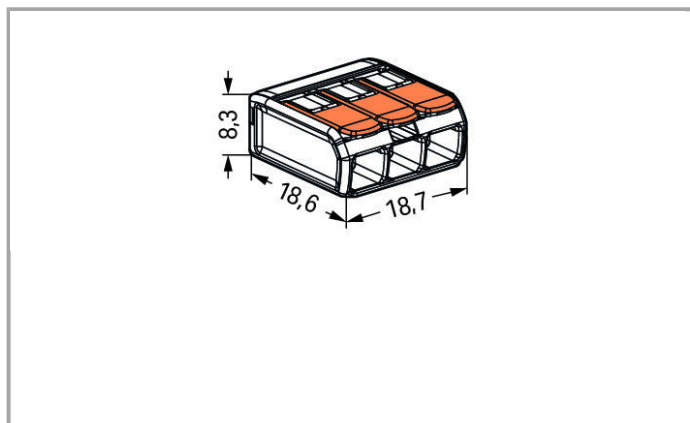

[www.wago.com/221-413](http://www.wago.com/221-413)



## Data

### Electrical data

#### Ratings per IEC/EN 60664-1

Rated voltage (II / 2)	450 V
Rated impulse voltage (II / 2)	4 kV



Rated current	32 A
Legend (ratings)	(II / 2) $\triangleq$ Overvoltage category II / Pollution degree 2

### Connection data

Connection technology	CAGE CLAMP®
Actuation type	Lever
Connectable conductor materials	Copper
Nominal cross section	4 mm <sup>2</sup>
Solid conductor	0.2 ... 4 mm <sup>2</sup> / 24 ... 12 AWG
Stranded conductor	0.2 ... 4 mm <sup>2</sup> / 24 ... 12 AWG
Fine-stranded conductor	0.14 ... 4 mm <sup>2</sup> / 24 ... 12 AWG
Strip length	11 mm / 0.43 Inch
Total number of connection points	3
Total number of potentials	1
Type of wiring	Side-entry wiring

### Geometrical Data

Width	18.7 mm / 0.736 inch
Height	8.3 mm / 0.327 inch
Depth	18.6 mm / 0.732 inch

### Material Data

Color	transparent
Flammability class per UL94	V2
Weight	2.527 g

### Environmental Requirements

Surrounding air (operating) temperature	85 °C
T-Marking per EN 60998	T85

### Commercial data

Country of origin	DE
GTIN	4050821808442
Product Group	7 (Push Wire Conn.)

### Approvals / Certificates

#### Country specific Approvals

Logo	Approval	Certificate name
	CCA DEKRA Certification B.V.	NTR NL-7642



# CCA





CCA  
DEKRA Certification B.V.

71-101731

## Ship Approvals



Logo	Approval	Certificate name
	<b>ABS</b> American Bureau of Shipping	15-HG1419918-PDA
	<b>DNV GL</b> Det Norske Veritas, Germanischer Lloyd	TAE000015T
	<b>LR</b> Lloyds Register	04/20013 (E6)

## UL-Approvals







Logo	Approval	Certificate name
	<b>UL</b> UL International Germany GmbH	E69654
	<b>UL</b> Underwriters Laboratories Inc.	E201573

## Compatible products

### Mounting adapter

	<b>Item no.: 221-500</b> Mounting carrier; for 221 series COMPACT splicing connectors; orange	<a href="http://www.wago.com/221-500">www.wago.com/221-500</a>
	<b>Item no.: 221-503</b> Mounting carrier; for 3-conductor terminal blocks; 221 Series - 4 mm <sup>2</sup> ; for screw mounting	<a href="http://www.wago.com/221-503">www.wago.com/221-503</a>
	<b>Item no.: 221-503/000-004</b> Mounting carrier; for 3-conductor terminal blocks; 221 Series - 4 mm <sup>2</sup> ; for screw mounting	<a href="http://www.wago.com/221-503/000-004">www.wago.com/221-503/000-004</a>

**Item no.: 221-513**

	Mounting carrier; for 3-conductor terminal blocks; 221 Series - 4 mm <sup>2</sup> ; with snap-in mounting foot for horizontal mounting	<a href="http://www.wago.com/221-513">www.wago.com/221-513</a>
	<b>Item no.: 221-513/000-004</b> Mounting carrier; for 3-conductor terminal blocks; 221 Series - 4 mm <sup>2</sup> ; with snap-in mounting foot for horizontal mounting	<a href="http://www.wago.com/221-513/000-004">www.wago.com/221-513/000-004</a>
	<b>Item no.: 221-523</b> Mounting carrier; for 3-conductor terminal blocks; 221 Series - 4 mm <sup>2</sup> ; with snap-in mounting foot for vertical mounting	<a href="http://www.wago.com/221-523">www.wago.com/221-523</a>
	<b>Item no.: 221-523/000-004</b> Mounting carrier; for 3-conductor terminal blocks; 221 Series - 4 mm <sup>2</sup> ; with snap-in mounting foot for vertical mounting	<a href="http://www.wago.com/221-523/000-004">www.wago.com/221-523/000-004</a>
	<b>Item no.: 222-505</b> Strain relief plate; for 221-500 or 222-500 mounting carrier; snap on; orange	<a href="http://www.wago.com/222-505">www.wago.com/222-505</a>
	<b>Item no.: 222-510</b> Angled DIN-rail adapter; for 221-500 or 222-500 mounting carrier; gray	<a href="http://www.wago.com/222-510">www.wago.com/222-510</a>

## Downloads

### Documentation

#### Bid Text

221-413	Mar 9, 2018	DOC 25.6 kB	Download
---------	-------------	----------------	----------

## CAD files

### CAD data

3D Download 221-413	URL	Download
---------------------	-----	----------

Subject to changes.